

FlexDSL Telecommunications AG offers some cables and accessories for Orion/Discovery/Plex:

Cable Specifications

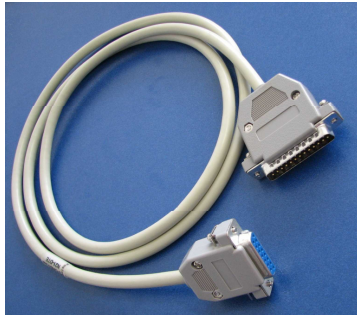

X.21 Cable for FG-PAM-XXX-XXX/N64

D-Sub 25pin Male to D-Sub 15pin Male, Cable 1.5m
(Item Number FG-CAB-N21-DCE)

D-Sub 25pin Male to D-Sub 15pin Female, Cable 1.5m
(Item Number FG-CAB-N21-DTE)



V.35 Cable for FG-PAM-XXX-XXX/N64

D-Sub 25pin Male to V.35 (MRAC-34) Male, Cable 1m
(Item Number FG-CAB-N35-DCE)

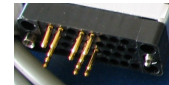

D-Sub 25pin Male to V.35 (MRAC-34) Female, Cable 0.5m
(Item Number FG-CAB-N35-DTE)



V.24 Cable for FG-PAM-XXX-XXX/N64

D-Sub 25pin Male to D-Sub 9pin Female, Cable 1.0m
(Item Number FG-CAB-N24-DTE)



DSL Cable for FG-PAM-XXX-XXX (1 or 2 Pairs)

RJ-45 to open End, Cable 2.5m
(Item Number FG-CAB-RJ45)



E1 Cable for FG-PAM-XXX-E1B/XXX

D-Sub 15pin Female to dual open End, Cable 1.5m
(Item Number FG-CAB-E1B)



48VDC power Cable for FG-PAM-XXX-XXX

Molex to open End, Cable 2.0m
(Item Number FG-CAB-Power-Molex)



V.35 Cable for FG-PLEX-xx

D-Sub 26pin Male to V.35 (MRAC-34) Male, Cable 1.5m
(Item Number FG-CAB-PLEX-N35-DCE)

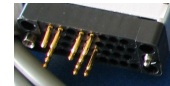

D-Sub 26pin Male to V.35 (MRAC-34) Female, Cable 1.5m
(Item Number FG-CAB-PLEX-N35-DTE)



Connector Specifications



E1 and 48VDC Connectors for FG-PAM-XXX-XXX

Connector D-Sub 15pin Female with Hood
(Item Number FG-DB15)

Connector Molex Mini-Fit 4pin with 4 Contacts (Crimp)
(Item Number FG-molex)

Adapter Specifications



Adapter for 120 Ohm E1 to 75 Ohm E1

Connector RJ-45 to BNC
(Item Number FG-ADAPT-E1B/E1U)

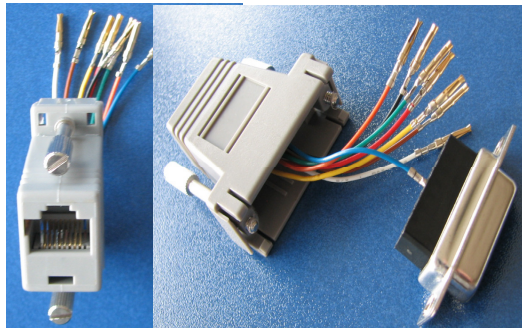
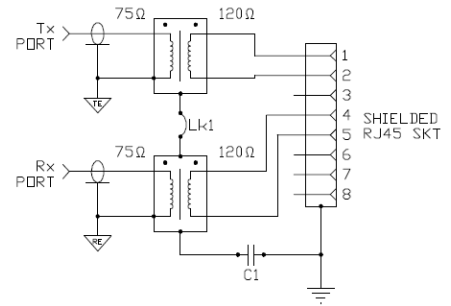

Adapter for DB15 to RJ-45 (All Orion's)

Connector D-Sub 15pin Female to RJ-45
(Item Number FG-ADAPT-E1B/RJ45)

Modem	RJ-45	cable	D-Sub-15
RXA (input)	Pin1	blue	Pin3
RXB (input)	Pin2	orange	Pin11
TXA (output)	Pin4	red	Pin1
TXB (output)	Pin5	green	Pin9

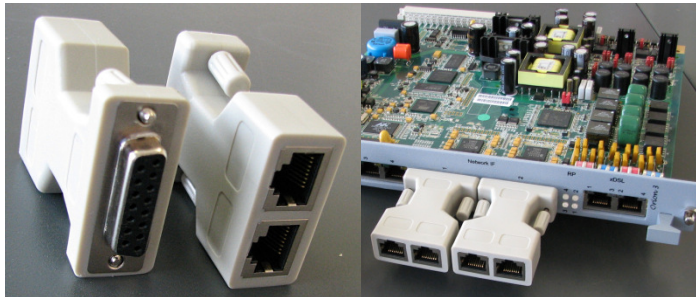

Adapter for DB15 to 2x RJ-45 (All Orion's)

Connector D-Sub 15pin Fem to 2xRJ-45
(Item Number FG-ADAPT-E1B/2xRJ45)

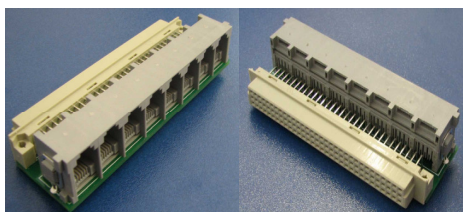

Analog Voice Interfaces Adapter for FG-PAM-XXX-XXX/FXx

DIN41612 to 8x RJ-11 Adapter
(Item Number FG-IAD-8V)

If you have any question please do not hesitate to call us on +41 44 741 5290 or by sending an e-mail to info@flexdsl.ch.